



**ANCHOR
BOLT, INC.**
Building America Since 1979

7390 Salem Road | Northville, MI 48168
PH: 800-929-3845 | 248-349-6565
FX: 248-349-8992 | AAAnchorBolt.com
Sales@AAAnchorBolt.com

Date: _____

Customer Name: _____

Order #: _____

PO #: _____

STRAIN POLE

MDOT 1 3/4" - 5 F1554 Grade 105

Domestic, Rolled Threads

Plain

Galvanized

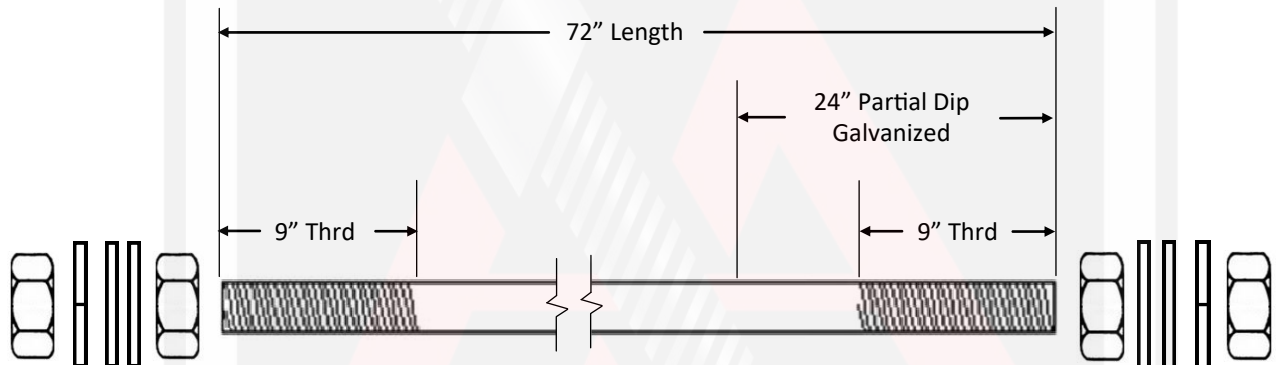

- (2) 2H Hex Nuts
- (2) F436 Washers
- (1) F436 Lock Washer

- (2) Galv. 2H Hex Nuts
- (2) Galv. F436 Washers
- (1) Galv. F436 Lock Washer

Quantity: _____

ADDITIONAL INFORMATION: